

# AMS Visitor Management V5.0



# Table of contents

<b>1</b>	<b>Introduction</b>	<b>5</b>
1.1	Functionality change log	5
1.2	About Bosch Visitor Management	5
1.3	Intended audiences	5
1.4	How to use this documentation	6
<b>2</b>	<b>System overview and topology</b>	<b>7</b>
<b>3</b>	<b>Installing and uninstalling</b>	<b>8</b>
3.1	Software and hardware requirements	8
3.1.1	The main access control system	8
3.1.2	A database instance to host the Visitor Manager database	8
3.1.3	A dedicated user for local database access	9
3.1.4	A dedicated user for remote database access	9
3.1.5	A dedicated user in the main access control system	9
3.2	Installing the Server	9
3.2.1	Running the server setup program	9
3.2.2	Appsettings JSON file	10
3.3	Setting up the VisMgmt client computer	11
3.3.1	Setting up the Peripheral Devices add-on	11
3.3.2	Certificates for secure communication	12
3.3.3	Certificates for the Firefox browser	12
3.3.4	Appsettings JSON file	13
3.4	Verifying server installation	13
3.5	Peripheral hardware	14
3.5.1	Registering peripheral hardware with the client computer	14
3.6	Uninstalling the software	14
<b>4</b>	<b>Configuration</b>	<b>15</b>
4.1	Creating Visitor Management users in the ACS	15
4.2	Creating Visitor authorizations and profiles in the ACS	16
4.3	Setting up the Receptionist computer	16
4.4	Setting up a kiosk computer for Visitors	16
4.5	Logging on for configuration tasks	16
4.6	Using the Settings menu for configuration	17
4.6.1	Email templates	18
4.6.2	Preview mode	20
4.6.3	Customizing the UI	20
4.6.4	Document templates	21
4.7	Firewall settings	21
4.8	Network security	21
4.9	Backing up the system	22
<b>5</b>	<b>Operation</b>	<b>23</b>
5.1	Overview of user roles	23
5.2	Using the dashboard	23
5.2.1	The visits table	23
5.2.2	Table columns and actions	24
5.3	Receptionist	26
5.3.1	Logging onto the Receptionist role	26
5.3.2	Searching and filtering visits	26
5.3.3	Registering visits	26

---

<b>5.3.4</b>	Approving and declining visitors	<b>27</b>
<b>5.3.5</b>	Adding, removing and exempting from the blacklist	<b>28</b>
<b>5.3.6</b>	Assigning and deassigning cards	<b>29</b>
<b>5.3.7</b>	Checking in and out without card	<b>30</b>
<b>5.3.8</b>	Maintaining visitor profiles	<b>31</b>
<b>5.3.9</b>	Viewing visit records	<b>32</b>
<b>5.4</b>	Host	<b>32</b>
<b>5.4.1</b>	Logging onto the Host role	<b>32</b>
<b>5.4.2</b>	Searching and filtering	<b>32</b>
<b>5.4.3</b>	Registering visits	<b>33</b>
<b>5.4.4</b>	Copying visit appointments	<b>33</b>
<b>5.5</b>	Visitor	<b>33</b>
<b>5.5.1</b>	Introduction to Kiosk mode	<b>34</b>
<b>5.5.2</b>	Creating a visitor profile: Self check-in	<b>34</b>

# 1 Introduction

## 1.1 Functionality change log

VisMgmt version	Added functionality	AMS version	BIS version
1.0	n/a	3.0.1	4.9
1.0.1	Checking visitors in and out without cards Searching for the numbers of free cards Distinguishing between different hosts with the same name (Performance enhancement) Finer granularity of dialog refresh	4.0	4.9.1
5.0	Support for mail server Support for HID Omnikey readers Customizable company logos	5.0	tbd

## 1.2 About Bosch Visitor Management

Bosch Visitor Management, hereafter referred to as VisMgmt is a browser-based software tool that operates in tandem with Bosch access control systems. It manages visits to an access-controlled site, including the scheduling of visits, the professional data of the visitor, associated documents and contracts, and the assignment of temporary credentials.

The user interface is customizable, and any user may change its language on-the-fly without logging out.

The primary users and their use cases are:

User type	Use cases
Receptionist	Registering new visits and visitors Approving and declining visits Blacklisting visitors Assigning and deassigning visitor cards Managing associated documents Monitoring the number of visitors on site
Visitor	Self-registration and pre-registration Creating and maintaining a visitor profile Signing documents
Host	Managing schedules and lists of visits and visitors Pre-registering visits
Administrator	Making global settings Customizing the behavior of the tool and its user interface Plus: All the use cases of Receptionist

## 1.3 Intended audiences

- Installers and administrators of VisMgmt
- The main user types of VisMgmt

## 1.4 How to use this documentation

- Use the **Search** function in your help viewer to locate relevant content.
- The **system overview, installation** and **configuration** sections are primarily of interest to system administrators
- The **operation** sections are primarily of interest to system users.

## 2 System overview and topology

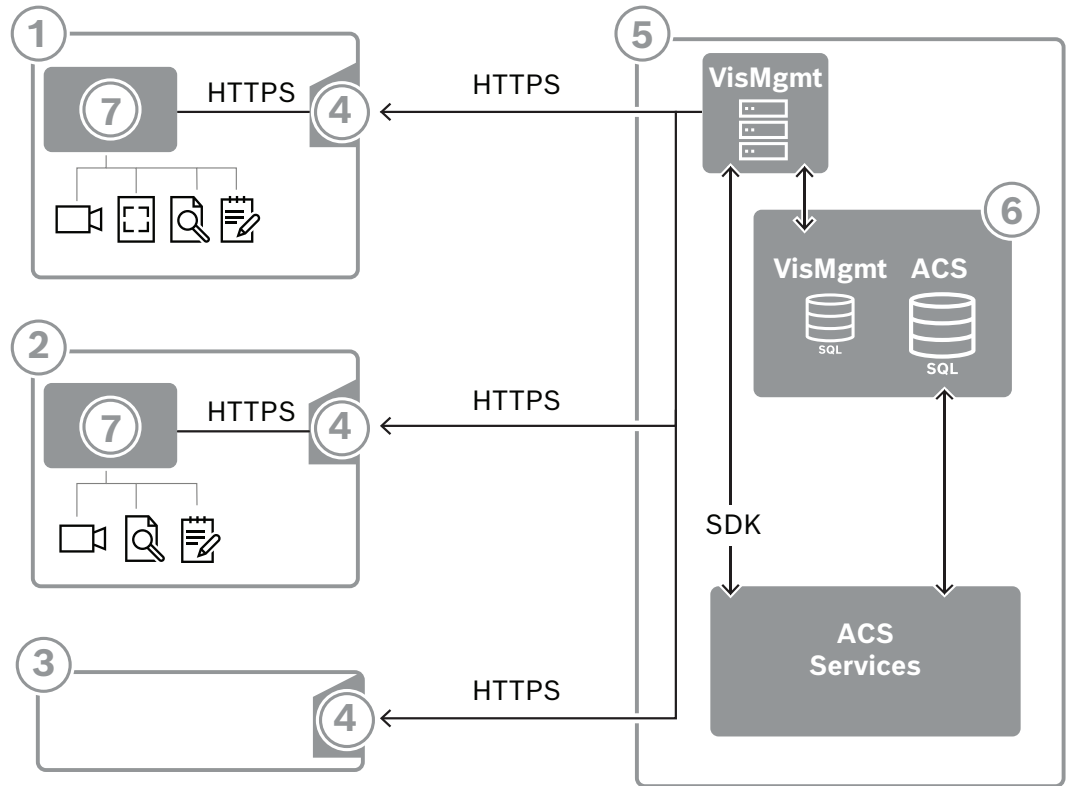

Label	Description
1	The <b>Receptionist</b> workstation. This workstation can have optional peripheral hardware, such as an enrollment reader, web camera, and scanners for signatures and documents.
2	The <b>Visitor</b> kiosk workstation, with supported browser in kiosk mode. This workstation can have optional peripheral hardware, such as a web camera and scanners for signatures and documents.
3	The <b>Host</b> workstation, that is, the workstation of the employee who receives the visitor.
4	Supported browser with the VisMgmt website
5	The ACS server (BIS or AMS)
6	The database instance of the ACS server (This can be on a separate computer).
7	The optional <b>Bosch Peripheral Device add-on</b> , which manages communication between the browser and peripheral hardware.

The recommended system topology has the VisMgmt server on the same computer as that of the main access control system, and its database on the same database instance.

The Bosch Peripheral Device add-on is installed only on those workstations that require access to peripheral devices.

The host workstation usually requires only browser access to the VisMgmt server.

## 3 Installing and uninstalling

### 3.1 Software and hardware requirements

Install VisMgmt server on the same computer as the main access control system: the same software and hardware requirements apply.

#### Server requirements

The server is the computer that runs the VisMgmt application.

<b>Operating systems</b>	<b>Windows 10, Windows Server 2016, Windows Server 2019</b>
Database management systems	For AMS 4.* and AMS 5.0: MS SQL Server 2019 and later Always use the same database instance as that of the ACS (the main access control system)
Supported browsers	Google Chrome, Mozilla Firefox, Microsoft Edge (Chromium based) Use the most recent version of the browser for your Windows operating system.
Minimum monitor resolution (for using the application UI)	Full HD 1920x1080

#### Requirements for the Bosch Peripheral Devices add-on

The **Bosch Peripheral Devices add-on** is the program that handles the electronic communication between the browser and peripheral devices such as enrollment reader, web camera, signature scanner and document scanner.

The client computer is the computer that is physically connected to the peripheral hardware. It also runs the browser that connects to the VisMgmt server.

Although the peripheral devices are not strict requirements for installation, they are urgently recommended, as they greatly increase the efficiency of the visitor registration process.

<b>Supported browsers</b>	<b>Google Chrome, Mozilla Firefox, Microsoft Edge (Chromium based)</b> <b>Use the most recent version of the browser for your Windows operating system.</b>
Minimum monitor resolution	Full HD 1920x1080

#### 3.1.1 The main access control system

VisMgmt version 5.0 works with the following Bosch access control systems:

- Access Management System (AMS) versions 5.0 and later

Complete and verify the installation of the main access control system, according to its own installation guide, before proceeding with the installation of VisMgmt .

#### 3.1.2 A database instance to host the Visitor Manager database

The installation of the main access control system creates a database instance which you can use to host the VisMgmt database, *dbVisitorManagement*.

The default name of this instance varies, depending on the ACS

- For AMS the name is *ACE*
- For BIS ACE the name is *BIS\_ACE*



### 3.1.3 A dedicated user for local database access

The user *VMUser* accesses the Visitor Manager database on behalf of the VisMgmt application. The VisMgmt server installation program creates a Windows user *VMUser* on the VisMgmt server.

### 3.1.4 A dedicated user for remote database access

If VisMgmt is to use a database on a remote database server, create and configure the *VMUser* user in Windows and on the SQL Server as described below.

**IMPORTANT:** Do not run the VisMgmt setup before completing this procedure.

1. On the remote database server create a Windows user with the following settings:
  - **Username** (case sensitive): *VMUser*
  - **Password:** Set the password according to the security policies that apply to all your computers. Note it carefully as it will be required for the VisMgmt setup.
  - **Member of group:** *Administrators*
  - **User must change password at next logon:** *NO*
  - **User cannot change password:** *YES*
  - **Password never expires:** *YES*
  - **Logon as a service:** *YES*
  - **Account is disabled:** *NO*

(Add *VMUser* as a login to remote the SQL Server)

1. Open SQL Management Studio
2. Connect to the remote SQL instance
3. Go to **Security > Login**
4. Add the user *VMUser* with server role *sysadmin*

Later, when you execute the VisMgmt setup on the VisMgmt server, you will select the option for **remote database server** computer and enter the password that you defined above for *VMUser*.

### 3.1.5 A dedicated user in the main access control system

1. In the main access control system, create a user that has the feature **unlimited API usage**.  
For detailed instructions, see the chapter **Assigning user (operator) profiles** in the operator manual of the main access control system.
2. Note the username and password carefully, because the VisMgmt installation wizards will require them.

## 3.2 Installing the Server

Do not start the setup program until you have provided all the software requirements.

### 3.2.1 Running the server setup program

1. On the intended VisMgmt server, as Administrator, run  
*BoschVisitorManagementServer.exe*.
2. Click **Next** to accept the default installation package.
3. If you agree with the End User License Agreement (EULA), accept it and click **Next**.

4. Select the destination folder for the installation. The default folder is recommended.
  - On the **SQL Server configuration** screen
5. Select whether you wish to create the database on the local SQL server instance, that is on the database instance on the VisMgmt server, or on a remote database server computer.
  - **Note:** If you choose a remote database server, the setup program prompts for the password of *VMUser*, the administrator user that you set up on the remote database server (see section Software requirements).
6. Check and, if necessary, modify the values for the following parameters:

<b>SQL server</b>	The name of the database server computer
<b>SQL instance</b>	The name of the instance of the main ACS database. This is where the visitor database is created. For AMS the name is <i>ACE</i> For BIS ACE the name is <i>BIS_ACE</i>
<b>SQL user name</b>	The name of an administrator user of the instance, typically <i>sa</i>
<b>SQL password</b>	The password of this administrator user.

7. Click **Test connection** to test whether the database instance can be reached using the parameter values that you have entered. If the test fails, re-check the parameters.
8. Click **Next** to continue
  - On the **ACS access configuration** screen (where ACS refers to the main access control system, AMS or ACE)
9. Enter values for the following parameters:

<b>ACS host name</b>	The name of the computer where the ACS is running
<b>ACS user name</b>	The name of the dedicated user of the ACS, with unlimited API usage. See section Software requirements.
<b>ACS password</b>	The password of this dedicated ACS user.

10. Click **Next** to continue
  - On the **Identity server configuration** screen
11. Enter the URI of the corresponding ACS identity server:
  - AMS: *HTTPS://<NameOfACSserver>:44333*
  - BIS: *HTTPS://<NameOfACSserver>/BisIdServer*
12. Click **Test connection** to test whether the identity server is reachable.
13. Click **Next** for the summary screen, then click **Install** to start the installation of the VisMgmt server.
14. After installation, reboot the computer.

### 3.2.2

#### Appsettings JSON file

A number of configuration parameters for the VisMgmt server are stored in the following *.JSON* file:

```
<installation drive>:\Program Files (x86)\Bosch Sicherheitssysteme\
Bosch Visitor Management\appsettings.json
```

It is generally not necessary to change the default values, but it may be beneficial to adjust the following parameters in the **Settings** section of the file. If you do adjust parameters, make a backup copy of the file first. The backup will help you revert changes quickly if your changes cause a malfunction.

Save your changes and restart the VisMgmt Windows service to put the changed parameters into effect. The name of the service is *Bosch Visitor Management*.

Parameter name	Default value	Description
<i>PageSizeNumberOfVisit</i>	20	The maximum number visit records that appear on the screen at one time. As the user scrolls, each new page is filled with this number of records, loaded from the database.
<i>MaximumUploadFileSizeBytes</i>	31457289	The maximum number of bytes that an uploaded file may contain.
<i>StartoverTimeoutAskSeconds</i>	300	The application waits this number of seconds if the user pauses during the input of login information, then it prompts for input.
<i>StartoverTimeoutResetSeconds</i>	60	After prompting, the application waits this number of seconds before resetting the login screen.

### 3.3 Setting up the VisMgmt client computer

The Bosch Peripheral Devices add-on can be installed on the server computer, but is usually installed on a separate computer in the same network. If so, copy the HTTPS certificate from ACS server and install it on the separate computer also. See *Certificates for secure communication, page 12* below for instructions.

The Bosch Peripheral Devices add-on is the connecting software for devices such as enrollment readers and scanners. If such devices are not required, for example for the host user, then browser access is enough to log in and run the VisMgmt application.

#### Refer to

- *Certificates for secure communication, page 12*

#### 3.3.1 Setting up the Peripheral Devices add-on

1. On the intended VisMgmt client computer, as Administrator, run *BoschPeripheralDeviceAddon.exe* from the installation medium.
  - The core components are listed, that is, the client software and the software for the usual peripheral devices. We recommend that you install all the listed components, even if you do not currently have the hardware available.
2. Click **Next** to accept the default installation packages.
  - On the **Client configuration** screen
3. Enter the name of the VisMgmt server, and the port number given on the screen (default value 5706).

4. COM port:
  - If using a LECTUS enroll reader, enter the number of the COM port, for example *COM3*, to which the enrollment reader is connected. Verify this value in the Windows device manager.
  - If using an HID OMNIKEY reader, leave this field blank.
5. Click **Next** for a summary of the components to be installed.
6. Click **Install** to start the installation.
7. Click **Finish** to finish the installation.
8. After installation, reboot the computer.

### 3.3.2 Certificates for secure communication

For secure communication between the browser on the client machine, the VisMgmt server computer, and the main access control system, copy the following certificate from the ACS server to the VisMgmt computers. Use an account with Windows administrator rights to install it.

The usual path to the certificate is:

- <installation drive> :  

```
\Bosch Sicherheitssysteme\Access Management System\Certificates\Bosch Security System Internal CA - BISAMS.cer
```

### 3.3.3 Certificates for the Firefox browser

You may ignore this section if you are not using the Firefox browser.

The Firefox browser handles root certificates differently: Firefox does not consult the Windows certificate store for trusted root certificates. Instead, each browser profile maintains its own root certificate store. For more details, refer to <https://support.mozilla.org/en-US/kb/setting-certificate-authorities-firefox>

This webpage also offers instructions for forcing Firefox to use the Windows certificate store for all users.

Alternatively, you can import the default certificates as described below. Note:

- You must import the certificates for each user and Firefox profile.
- The VisMgmt server certificate described below is the default certificate created by the installation. If you have purchased your own certificate from a Certificate Authority, then you can use that instead.

#### Importing certificates into the Firefox certificate store

**VisMgmt server:** To access the VisMgmt server from Firefox on the VisMgmt client computer, you can import the following default certificate from the server:

- <installation drive> :  

```
\Bosch Sicherheitssysteme\Access Management System\Certificates\Bosch Security System Internal CA - BISAMS.cer
```

Or, for BIS ACE, you can also download the certificate through the web:

- *HTTP://<Hostname>/<Hostname>.cer*

**Peripheral devices:** To access a connected peripheral device, such as a document or signature scanner, from Firefox on the VisMgmt client computer, you can use the default certificate. You can find it on the client computer at the following location:

```
<installation drive>:\Program Files (x86)\Bosch Sicherheitssysteme\
Bosch Peripheral Device Addon\BoschAcePeripheralDeviceAddonHardware CA.cer
```

**Procedure (repeat for each certificate and Firefox profile):**

Use the following procedure on the VisMgmt client computer to install the certificates you require:

1. Locate the certificate that you want to install.
2. Open Firefox browser and type *about:preferences* in the address bar.
  - An options page opens.
3. In the **Find in Options** field, type *certificate*
  - The **View Certificates** button appears on the page.
4. Click the **View Certificates** button.
  - The **Certificate Manager** dialog opens with several tabs
5. Select the **Authorities** tab.
6. Click **Import...**
  - A certificate selector dialog opens.
7. Select the certificate you located in step 1, and click **Open**.
  - The **Downloading Certificate** dialog opens.
8. Select **Trust this CA to identify websites** and click **OK**.
  - The **Downloading Certificate** dialog closes
9. In the **Certificate Manager** dialog, click **OK**.
  - The certificate import procedure is finished.

**3.3.4 Appsettings JSON file**

A number of configuration parameters for the VisMgmt client computer are stored in the following .JSON file:

```
<installation drive>:\Program Files (x86)\Bosch Sicherheitssysteme\
Bosch Visitor Management\appsettings.json
```

It is generally not necessary to change the default values, but it may be beneficial to adjust the following parameters in the **AppSettings** section of the file.

Save your changes and restart the VisMgmt Windows service to put the changed parameters into effect. The name of the service is *Bosch Ace Visitor Management Client*

Parameter name	Example	Description
<i>CorseOrigins</i>	"https://my-vm-server:5706"	The address and port number of the Visitor Management server.
<i>CardReaderPort</i>	"com3"	The COM port number to which a LECTUS enrollment reader is connected. For HID OMNIKEY readers this parameter can be blank.

**3.4 Verifying server installation**

From a computer in the same network, using one of the supported browsers, open the following URL:

```
https://<VisMgmt server computer>:5706/main
```

If the server is running, it displays the application login page.

## 3.5 Peripheral hardware

The following peripheral USB devices have been tested and approved for use with Bosch Visitor Management at the time of writing. For a continually updated list of compatible devices, consult the datasheet of the main access control system.

Card enrollment reader	LECTUS enroll 5000 MD, HID OMNIKEY
Scanner for ID documents	ARH Combo, ARH Osmond
Signature scanner	signotec LITE, signotec Omega

Follow the manufacturer's instructions to connect these devices to your VisMgmt client computers. The client setup program installs the necessary connecting software for communication with VisMgmt.

### 3.5.1 Registering peripheral hardware with the client computer

To register peripheral hardware with the VisMgmt client computer, run the Bosch Peripheral Devices setup program, *BoschPeripheralDeviceAddon.exe*, on the client. For instructions see *Setting up the Peripheral Devices add-on*, page 11.

#### Refer to

- *Setting up the Peripheral Devices add-on*, page 11

## 3.6 Uninstalling the software

To uninstall VisMgmt from the VisMgmt server or client:

1. With Windows administrator rights, start the Windows program **Add or remove programs**.
2. Select the **Bosch Visitor Management** program (server or client) and click **Uninstall**.
3. (For the server only) Select whether you want to remove the visitor management database as well as the program.
  - **Note:** The database contains records of all the visits that were registered while the program was in use. You may wish to archive the database or transfer it to another VisMgmt installation.
4. Select whether you want to remove the VisMgmt log files.
5. Complete the uninstallation in the usual way.
6. (Recommended) Reboot the computer to ensure complete modification of the Windows registry.

## 4 Configuration

### 4.1 Creating Visitor Management users in the ACS

#### Introduction

Every Administrator, Receptionist or Host user of VisMgmt must be a cardholder with a separate Operator definition in the ACS, that is, the main access control system.

These Operator definitions contain special VisMgmt rights in the form of **User profiles**. See the online help in your ACS for detailed information and instructions regarding **User profiles**.

- You must define a separate Operator for each cardholder who works in Visitor management. You cannot assign multiple cardholders to the same Operator.



#### Notice!

IT security and user accounts

In accordance with best practices for IT security, we recommend that each Receptionist, Host and Administrator user work under his own Windows account.

#### Creating User profiles for Visitor management

1. Log onto the main access control system with administrator privileges.
2. Create one or more user (operator) profiles for VisMgmt users.

Dialog path:



- **Configuration > Operators and workstations > User profiles**
- 3. Assign one of the following user rights to these profiles.
  - Administrator: *Visitor Management > Administrator*
  - Host: *Visitor Management > Host*
  - Receptionist: *Visitor Management > Receptionist*

When you have created the user profiles that you require for the various VisMgmt roles (Administrator, Receptionist, Host), you can assign each profile to multiple Operators.

#### Assigning User profiles to ACS operators and cardholders

Dialog path:

- **Configuration > Operators and workstations > User rights**

1. Add a new operator type (Click  or , depending on the ACS) and give it a name that clearly relates to one of the VisMgmt roles (Administrator, Host or Receptionist).
2. On the tab **General operator settings**, select *Operator ACE* from the Authorization list.
3. On the tab **ACE operator settings**, use the arrow buttons to assign the **ACE user profile** that you created above.

Deassign the default profile *UP-Administrator*, except in the unlikely case that the cardholder requires general administrator rights in the ACS.

4. Still on the tab **ACE operator settings**, use the **Assign person** pane to find the cardholder in the system who is to have the VisMgmt role.
5. Click **Assign person** to complete the assignment to the selected cardholder.
  - You must define a separate Operator for each cardholder who works in Visitor management. You cannot assign multiple cardholders to the same Operator.

## 4.2 Creating Visitor authorizations and profiles in the ACS

### Introduction

The receptionist or administrator of the VisMgmt system selects for each new visitor a **Visitor type**. This visitor type is based on a predefined **Person type** called **Visitor** in the main access control system (ACS), or on a subtype of **Visitor** that the administrators of the ACS have created.

These administrators must also configure the Person type **Visitor** and its subtypes in the ACS with access profiles. The access profiles allow these person types to operate real doors on the site.

## 4.3 Setting up the Receptionist computer

The receptionist's computer runs the **Bosch Peripheral Devices** add-on, which allows it physical connections to peripheral devices for reading cards, scanning ID documents and scanning signatures.

Connect all required peripheral devices before installing the client software.

Make sure that the computer and its peripheral devices are adequately protected from unauthorized access.

## 4.4 Setting up a kiosk computer for Visitors

### Introduction

Visitors typically register their visits, and create their own profiles, at a computer that is freely accessible in the reception area of the access-controlled site. For security reasons, the computer's web browser runs in kiosk mode, which allows access only to VisMgmt, and not to multiple tabs, browser settings, or the computer's operating system. All the supported browsers offer kiosk mode, but its exact configuration depends on the browser.

The kiosk computer runs the **Bosch Peripheral Devices** add-on, which allows it physical connections to peripheral devices for scanning ID documents and signatures.

– The URL for kiosk mode is `https://<My_VisMgmt_server>:5706`

### Configuring browsers for kiosk mode

The following links describe the configuration of kiosk mode for browsers supported by VisMgmt

	Instructions for setting up kiosk mode
<b>Chrome</b>	<a href="https://support.google.com/chrome/a/answer/9273974">https://support.google.com/chrome/a/answer/9273974</a>
<b>Firefox</b>	<a href="https://support.mozilla.org/en-US/kb/firefox-enterprise-kiosk-mode">https://support.mozilla.org/en-US/kb/firefox-enterprise-kiosk-mode</a>
<b>Edge</b>	<a href="https://docs.microsoft.com/en-us/deployedge/microsoft-edge-configure-kiosk-mode">https://docs.microsoft.com/en-us/deployedge/microsoft-edge-configure-kiosk-mode</a>



### Notice!

For security reasons, always disable the browser option for saving passwords automatically.

## 4.5 Logging on for configuration tasks

For configuration and administration tasks, use a computer that is physically protected from unauthorized access.



1. In your browser, enter the HTTPS address of the VisMgmt server followed by a colon and the port number (default 5706)  
`https://<My_VisMgmt_server>:5706/main`  
 The **Login** screen appears
2. Log on as a VisMgmt **Administrator** user.
3. Click  to open the **Settings** menu.

## 4.6 Using the Settings menu for configuration

The **Settings** menu contains subsections that let you perform the following configuration steps:

<b>General settings</b>	<ul style="list-style-type: none"> <li>- <b>Retention period (days):</b> This setting governs the handling of visit records.                             <ul style="list-style-type: none"> <li>- When the period elapses for the first time, the application anonymizes the record.</li> <li>- When the period elapses for the second time, the application deletes the record.</li> </ul>                             Default value is <i>365</i>.                              Set 0 to deactivate the retention period completely. In this case visit records are retained indefinitely.                         </li> <li>- <b>Document storage mode:</b> Select whether documents are to be stored as paper or digital files.</li> <li>- <b>Maximum number of visitors</b> allowed on the site at one time.                              Default value is <i>100</i>.                              Set 0 to deactivate the visitor counters on the dashboard completely.</li> <li>- <b>Document expiry period (days):</b> Enter how long uploaded documents, such as non-disclosure agreements (NDA) and Terms of Use, are to remain valid. The period applies to both paper and digital files.                              After this period, the documents are marked as expired in the visitor's profile (clock icon with a red dot).                              Default value is <i>365</i></li> <li>- <b>Document expiry warning period (days):</b> Enter the length of the warning period before the expiry date.                              During this warning period, documents are marked in the visitor's profile (clock icon with an orange dot). Before the warning period the clock icon has a green dot.</li> <li>- Select or clear the check boxes that govern whether the dialogs display a customized logo the Bosch <b>Supergraphic</b> and the <b>Bosch logo</b>.</li> <li>- Click <b>Preview</b> to show the dialog page as it would appear with these settings. See the next section for more details on Preview mode.</li> <li>- <b>Languages:</b>                              Select which languages are to be available in the user interface, along with their preferred <b>date</b> and <b>time</b> formats.</li> </ul>
-------------------------	--

	<ul style="list-style-type: none"> <li>– <b>Email server</b> Enter the IP address, port number and account details of your email server, in order to enable the sending of emails from the application.</li> <li>– <b>Email templates</b> Several HTML email templates are provided, which you typically customize to your own requirements. For details, see the separate section <b>Email templates</b> below.</li> </ul>
<b>Receptionist</b>	<ul style="list-style-type: none"> <li>– This settings screen contains 2 check boxes for each of the data fields in the receptionist's visitor registration dialogs. <ul style="list-style-type: none"> <li>– Clear or select the first check box to govern whether the data field is <b>visible</b> at all the registration dialogs.</li> <li>– Clear or select the second check box (marked with an asterisk) to govern whether the data field is <b>mandatory</b>.</li> </ul> </li> <li>– Customize the default header texts in the data-collection dialogs. For more details, see <i>Customizing the UI</i>, page 20 below.</li> </ul> <p><b>Special option: Enable check-in/check-out without card</b> If visitors have close escorts, or are restricted to public spaces, individual cards for visitors may be unnecessary. For such cases there exists the option of checking visitors in and out without cards. For security reasons this option is disabled by default. Select the check box to enable it:</p> <ul style="list-style-type: none"> <li>– <b>Note:</b> if the option is enabled then any <b>Visitor</b> who self-registers at the kiosk computer automatically approves and checks in their own visit at the same moment.</li> <li>– See the <b>Operation</b> chapter <i>Checking in and out without card</i>, page 30 of this document for details on how a <b>Receptionist</b> user processes visitors without cards.</li> </ul>
<b>Host</b>	<p>The settings for the <b>Host</b> and <b>Visitor</b> users remain read-only until you have edited and saved the settings for <b>Receptionist</b>.</p> <p>Fields that you mark as not visible in the <b>Receptionist</b> settings are automatically set not visible for <b>Host</b> and <b>Visitor</b>.</p> <p>After that, the configuration procedure is identical.</p>
<b>Visitor</b>	

**Refer to**

- *Assigning and deassigning cards*, page 29
- *Customizing the UI*, page 20

**4.6.1****Email templates**

Several HTML email templates are provided, which you typically customize to your own company requirements. For each template, you can store mail addresses for CC, BCC and a test receiver, to whom you can send a test email immediately. The templates are stored in <installation drive>:\Users\Bosch\Downloads

- *VisitorInvite.html* An invitation for someone to visit your site, with the option to append an iCalendar file to the email.
- *InformHostAboutCheckin.html* An email to inform the host that a visitor has arrived.

### Placeholders for use in email templates

The email templates provide several text placeholders for including database fields in the text. These placeholders are described in the following tables, according to the templates where they can be used.

<b>Visitor invite</b>		
Email that is sent to a visitor when a visit is created or edited for him		
	<b>Placeholder</b>	<b>Description</b>
	{{VisitorID}}	visitor's ID code, as generated by the VisMgmt application
	{{FirstName}}	visitor's first name
	{{LastName}}	visitor's surname
	{{CompanyName}}	visitor's company
	{{HostFirstName}}	host's first name
	{{HostLastName}}	host's surname
	{{ExpArrivalDate}}	planned date of visit

<b>Visitor Arrived</b>		
Email that is sent to a host when the visitor arrives		
	<b>Placeholder</b>	<b>Description</b>
	{{VisitorID}}	visitor's ID code, as generated by the VisMgmt application
	{{FirstName}}	visitor's first name
	{{LastName}}	visitor's surname
	{{CompanyName}}	visitor's company
	{{HostFirstName}}	host's first name
	{{HostLastName}}	host's surname
	{{ExpArrivalDate}}	planned date of visit
	{{ArrivalDate}}	actual date of visit

<b>Visitor Pass</b>		
Document that can be printed out and given to a visitor. This could contain a map of the building or a checklist.		
	<b>Placeholder</b>	<b>Description</b>
	{{VisitorID}}	visitor's ID code, as generated by the VisMgmt application
	{{FirstName}}	visitor's first name
	{{LastName}}	visitor's surname
	{{CompanyName}}	visitor's company

Visitor Pass		
	{{HostFirstName}}	host's first name
	{{HostLastName}}	host's surname
	{{ExpArrivalDate}}	planned date of visit
	{{ArrivalDate}}	actual date of visit

## 4.6.2

### Preview mode

Certain sets of options provide a **Preview** button that activates preview mode, to let you to see the dialogs as they would appear when those options are set.

In preview mode, the following conditions apply:

- A banner appears at the top of the dashboard.

 **Preview mode. Any changes will not be applied. Close preview-mode or change role** 

- Changes made in the dashboard or menus are **not** saved.
- Click **Close preview mode** within the banner to close preview mode
- Use the **Change role** list within the banner to preview the appearance of the interface for the different user types: **Receptionist, Host, Visitor**.

## 4.6.3

### Customizing the UI

Customize the user interface in the **Dashboard > Settings** dialogs,

#### Setting options visible, invisible and mandatory

Select which data fields will be visible in the dialogs, and which of those data are mandatory.

Example:

<input checked="" type="checkbox"/>	(1)	<input checked="" type="checkbox"/> *
<input checked="" type="checkbox"/>	(2)	<input type="checkbox"/> *
<input type="checkbox"/>	(3)	<input type="checkbox"/> *

- (1) is visible and mandatory,
- (2) is visible but not mandatory
- (3) is not visible.

#### Customizing UI texts for localization

You can easily customize the texts of the user interface on a per-language basis.

By default, **localization text** contains the standard headers for blocks of data fields in the data collection dialogs.

To customize these headers to local requirements:

1. Select a UI language from the list.
2. Overwrite the texts in the text box.

You may use HTML tags for simple formatting, for example:

```
<b>this text will appear bold </b>
<i>italics</i>
<u>underline</u>
```

Localization text

General information

Locale

EN 

### Customizing kiosk mode

If your site lacks one or more peripheral hardware devices, for example a document scanner, you can customize the visitor's self-registration process in kiosk mode by clearing the check boxes for the corresponding registration steps.

## 4.6.4 Document templates

Upload templates for various documents and emails in the **Dashboard > Settings > General** dialog.

## 4.7 Firewall settings

Add Visitor Management to the firewall configuration of server and client computers:

1. Start the Windows Firewall click Start > **Control Panel > Windows-Firewall**
2. Select **Advanced settings**
3. Select **Inbound Rules**
4. In the **Actions** pane, select **New Rule...**
5. In the **Rule Type** dialog, select **Port** and click **Next >**
6. On the next page, select **TCP and Specific local ports**
7. Allow communication through the following ports:
  - On the server computer
    - [Server name]:44333* - used by the AMS Identity Server
    - [Server name]:5706* - used by the VisMgmt Server
  - On client computers
    - localhost:5707* - used by the Bosch Peripheral Device add-on

## 4.8 Network security

The security of an organization's access control systems is a critical part of its infrastructure. Bosch advises strict adherence to the IT-security guidelines prescribed for the country of installation.

The organization that operates the access control system is basically responsible for at least the following:

### Hardware responsibilities

- The prevention of unauthorized physical access to network components, such as RJ45 connections.
  - Attackers need physical access in order to carry out man-in-the-middle attacks.
- The prevention of unauthorized physical access to the AMC2 controller hardware.
- Use of a dedicated network for access control.
  - Attackers can gain access via other devices within the same network.
- The use of secure credentials such as **DESFire** with Bosch code and multi-factor authentication with biometry.
- Providing a failover mechanism and a backup power supply for the access control system.
- The tracking and disabling of credentials claimed to have been lost or misplaced.
- The proper decommissioning of hardware that is no longer in use, in particular its reset to factory defaults, and the deletion of personal data and security information.

### Software responsibilities

- The proper maintenance, update and functioning of the access control network's firewall.
- The monitoring of alarms that indicate when hardware components, such as card readers or AMC2 controllers, go offline.
  - These alarms may indicate an attempt to swap hardware components.

- The monitoring of tamper-detection alarms triggered by electric contacts in access control hardware, for example, controllers, readers and cabinets.
- The limiting of UDP broadcasts within the dedicated network.
- Updates, especially security updates and patches, to the access control software.
- Updates, especially security updates and patches, to the hardware's firmware.
  - Note that even recently delivered hardware may require a firmware update. See the hardware manual for instructions.
  - Bosch assumes no liability for damages caused by products put into operation with outdated firmware.
- The use of OSDPV2 secure-channel communication.
- The use of strong password phrases.
- The enforcement of the Principle of least privilege to ensure that individual users have access only to those resources that they require for their legitimate purpose.

## 4.9 Backing up the system

VisMgmt is an auxiliary web application for a main access control system. Consult the documentation for the main access control system regarding the backup of system databases.

# 5 Operation

## 5.1 Overview of user roles

User type	Use cases
Receptionist	Registering new visits and visitors Approving and declining visits Blacklisting visitors Assigning and deassigning visitor cards Managing associated documents Monitoring the number of visitors on site
Visitor	Self-registration and pre-registration Creating and maintaining a visitor profile Signing documents
Host	Managing schedules and lists of visits and visitors Pre-registering visits
Administrator	Making global settings Customizing the behavior of the tool and its user interface Plus: All the use cases of Receptionist

## 5.2 Using the dashboard

The dashboard is the home screen - a central dialog that leads to all other dialogs.

### Overview and quick filters

The top of the dashboard contains a quick overview of the day's visits. This enables the user easily to monitor the number of visitors on site.

Visitors expected today: _%	Visitors checked in: _%	Visitors still to check out today	Visitors overdue for check-out
<current count> / <total capacity>	<current count> / <total capacity>	<current count>	<current count>

Click any of the headers to filter the visits table according to the meaning of the header. For example, click **Visitors checked in** to see only those visitors to whom a card is assigned. The value for <total capacity> is a configuration setting, made by the system administrator. See *Using the Settings menu for configuration, page 17*.

### 5.2.1 The visits table





Each row in the table represents an appointment for a visit.

- You can sort the table by any of its columns by clicking the column header.
- You can select individual visits, or several visits at once, by using the keyboard-mouse idioms:
  - Ctrl-click for multiple selection of individual lines.
  - Ctrl-click on an already selected line to remove it from the selection.
  - Shift-click for multiple selection of contiguous lines
- You can add new visits to the table
- You can process visits and visitor details by clicking the action buttons
  - Approve visit

- Decline visit
- Assign cards to the visitor
- Edit visit and visitor details
- You can export the currently filtered lines to a *.CSV* or *.XLSX* file.

The horizontal tool bar has the following functions:



Label	Function
<b>1</b> N entries	The total number N of visits (each visit is a row in the table).
<b>2</b> Search	Search for arbitrary text among the visits in the table
<b>3</b> 	Show the visits that were added most recently to the table.
<b>4</b> 	Open a dialog for selecting filter criteria
<b>5</b> 	Reset the table to its default view, and revert all filters.
<b>6</b> Deassign card	Open a dialog for deassigning assigned cards using a connected enrollment reader.
<b>7</b> 	Open a dialog for creating a new visit entry in the table
...	Click the ellipsis symbol for a menu to export the currently filtered visits, and also documents, to various file formats, for example <i>.CSV</i> and <i>.XLSX</i> Note that for reasons of data security, you can only export if your client is running in a secured HTTPS connection, with a certificate.





### 5.2.2

#### Table columns and actions



##### Columns



Column	Value	Description
Status	 Visit expected	An icon reflecting the status of the visit



Column	Value	Description
	 Visit approved  Visit declined  Card assigned  Card expired  Visit ended (Visitor no longer holds cards, and has left the premises)	
<b>Name</b>	Visitor's name as a hyperlink	Click the hyperlink to view the details of the visitor and their current visit.
<b>Exp. arrival</b>	Date and time	The expected date and time of the visitor's arrival
<b>Exp. departure</b>	Date and time	The expected date and time of the visitor's departure
<b>Checked in</b>	Date and time	The date and time of the assignment of the first card to the visitor.
<b>Checked out</b>	Date and time	The date and time of the deassignment of the last card from the visitor.
<b>Card numbers</b>	Numeric	The numbers of the cards assigned to this visitor.
<b>Actions</b>	Icons	See separate table below

**Actions**

Icon	Function
	<p><b>Approve</b> the visit.</p> <p>NOTE: It is not possible to assign a card to visitors on the blacklist. First remove the visitor from the blacklist, or exempt them temporarily. See <i>Adding, removing and exempting from the blacklist</i>, page 28</p>
	<p><b>Decline</b> the visit.</p> <p>This button is deactivated after the visitor has checked in, that is, when they already have a card.</p>

Icon	Function
	<b>Assign</b> one or more cards to the visitor
	<b>Edit</b> the visit event and/or the visitors credentials

## 5.3 Receptionist

### 5.3.1 Logging onto the Receptionist role

1. In your browser, open `https://<My_VisMgmt_server>:5706/main/` for the login screen.
2. Enter the username of an account with the required rights for your role.  
Consult your system administrator if you do not have an account.
3. Enter the password.
4. Click **Login**.

### 5.3.2 Searching and filtering visits

On the VisMgmt dashboard, in the toolbar above the visits table.

#### Search

To search names and hosts, enter alphanumeric text in the search box, and press Return.

#### Filtering

- To see the visits that are closest to the current time, click **Latest**
- To construct a complex filter from visit status, dates of check-in and check-out, and card numbers, click **Filter**.
  - Enter the desired filter criteria in the popup dialog
  - Click **Apply**  
The system reduces the visits table to only those visit appointments that meet the filter criteria.
- To delete all filter criteria click **Reset**

### 5.3.3 Registering visits

#### Introduction

A receptionist has two basic scenarios for registering visits:

- **A:** When a visitor uses the visitor kiosk to create their own visitor ID and upload documents, the receptionist needs only complete any required information and signatures that are still missing, and assign a card to the visitor.
- **B:** When a visitor bypasses the visitor kiosk and approaches the reception desk directly, the receptionist can register the visit from scratch: collect the required information, collect signatures for required documents, and assign a card to the visitor.

Scenario **A** is a subset of scenario **B**, so the complete scenario **B** is described here. The use of kiosk mode by a visitor is described in its own section. See *Introduction to Kiosk mode, page 34*.

#### Procedure

On the VisMgmt dashboard, in the toolbar above the visits table.

1. Click  to add a visit appointment to the visits table.

2. On the **Personal Data** dialog, enter the data that your site requires from visitors. Mandatory fields are marked with an asterisk (\*).  
You can enter data manually, but more quickly and accurately through a document scanner, if available at the receptionist's workstation. See *Peripheral hardware, page 14* for details on the supported peripheral devices.
  - **General information**
    - Locate and load an entire visitor profile created on a previous visit. To locate profiles click the  (search) icon, located at the **Last name\*** field.  
When a visitor profile is created, it receives a unique alphanumeric code that the visitor should carefully save, in order to accelerate the registration process for future visits.
    - Else, enter data by hand.
  - **ID photos**
    - **Upload** a photo from the file system.
    - **Capture** photos of the visitor from a connected web camera.
  - **Identity documents**
    - Click **Scan document** to read data from a document scanner (if available) and automatically complete the relevant data fields in the dialog.
    - Else, enter text by hand, if your system does not have a document scanner.
  - **Legal documents**
    - Load the documents that the visitor signed electronically at the kiosk.
    - If your system does not have a visitor kiosk, print out and file (with the visitor's signature) the required PDF documents stored on the file system.
3. Click **Next** to proceed to the **Visits** dialog.
4. On the **Visits** dialog, in the **Current visit** pane, enter the data that your site requires. Mandatory fields are marked with an asterisk (\*).
  - Select a **Visitor type**.  
This is either **Visitor** (default) or a customized subclass of **Visitor**, defined as a **Person type** in the main access control system.
  - Select under **Host** the name of the employee to be visited.
    - Note that you can select only cardholders of the main access control system.
    - A tooltip displays the person's email address as an aid to identification.
  - If the visitor requires an escort through the premises, select the name of the escorting employee under **Escort**.
    - Note that you can select only cardholders of the main access control system.
    - A tooltip displays the person's email address as an aid to identification.
  - If the visitor requires extra time to pass through a door, select the checkbox **Extended door opening time**
5. Click **Save**.  
Note that you will not be able to save the data until you have completed all mandatory fields.

**Refer to**

- *Peripheral hardware, page 14*



**5.3.4****Approving and declining visitors**

It is necessary to approve a visit before you can assign cards to a visitor. There are two places to approve or decline a visit:

- in the visits table on the dashboard

- in the visit editor

#### In the visits table:

- **Approve:** In the visits table, select a line from the table and click . After a confirmation popup, the icon turns gray to show that the visit is approved.
- **Decline:** In the visits table, select a line from the table and click . After a confirmation popup the Approve icon is restored to blue, to show that the visit still needs to be approved.

#### In the visit editor:

1. On the dashboard, in the visits table, select a line from the table and click  to edit the visit.
2. On the **Personal Data** dialog, click **Next**.
3. On the **Visits** dialog, click the **Approve** or the **Decline** button.
4. Confirm your action in the popup window.

### 5.3.5

#### Adding, removing and exempting from the blacklist

Visitors that are not welcome on site can be put on a blacklist. As long as a visitor is on the blacklist, you cannot assign a card to that person. You may remove the visitor from the blacklist at any time, or grant a temporary exemption, in order to assign a card.

##### Blacklisting

1. On the dashboard, in the visits table, select a line from the table and click  to edit a visit.
2. On the **Personal Data** dialog, click **Blacklist**.
3. In the popup window, confirm that you really want to blacklist this person.
4. In the next popup window, enter a reason for blacklisting, and confirm.
  - A banner **Blacklisted** appears in the visit editor,

 **Blacklisted**

- Two buttons appear under the banner: one for removing the visitor from the blacklist, and one for granting a temporary exemption.
- In the visits table the name of every blacklisted visitor appears with a warning triangle.

For example:  [Yadira Hamill](#)

### Removing and exempting

1. On the dashboard, in the visits table, select a line from the table where the visitor is



marked as blacklisted, and click  to edit the visit.

2. On the **Personal Data** dialog, click one of the following:
  - **Remove** to remove the visitor permanently from the blacklist.
  - **Exempt** to keep the visitor on the blacklist but allow the assignment of a card for this visit only.
3. Confirm your action in the popup window.

## 5.3.6

### Assigning and deassigning cards

#### Introduction

Assign a visitor card to every visitor whom you allow onto the premises. You can assign multiple cards to a single visitor if required.

- The **Checked-in** time of a visit is the time of the assignment of the first card.
- The **Checked-out** time of a visit is the time of the deassignment of the last card that is still assigned to the visitor.

The receptionist can assign and deassign cards easily from the dashboard, if an enrollment card reader is connected to the receptionist's computer.

Nevertheless the visit editor provides a way of assigning card numbers, if no such reader is available.



#### Notice!

Blacklisted persons cannot receive cards

It is not possible to assign cards to visitors who are on the blacklist. Remove the visitor from the blacklist, or create a temporary exemption for the visitor, before attempting to assign a card.

#### Assigning a card from the dashboard (requires an enrollment reader)

1. Have a physical visitor card ready to present to the enrollment reader.
2. In the visits table, approve the visit. See *Approving and declining visitors, page 27*



3. Select the row of the visit and click 
4. Follow the instructions in the popup for use of the enrollment reader.

#### Deassigning a card from the dashboard (requires an enrollment reader)

1. Collect the physical card from the visitor, and have it ready to present to the enrollment reader.
2. In the toolbar click **Deassign card**.
3. Follow the instructions in the popup for use of the enrollment reader.

### Assigning a card in the visit editor





1. On the dashboard, in the visits table, select a row in the table and click  to edit that visit.
2. On the **Personal data** dialog, click **Next**
3. On the **Visits** dialog, if the visit has not yet been approved, click **Approve**.
4. If you have an enrollment reader connected, click **Read card** and follow the instructions in the popup for use of the enrollment reader.  
Otherwise:
  - Click **Show free cards** to display a list of the visitor cards that are still available. Alternatively, if you have unsorted physical cards with printed numbers, select any card and use the **Search** tool to find its number quickly in the list.



- Click  next to a card number to assign that card to the current visitor.
  - Repeat the last steps to assign further cards, if required.
5. Click **Save** to save the current visit with the card assignments.

### Deassigning a card in the visit editor



1. On the dashboard, in the visits table, select a row in the table and click  to edit that visit.
2. On the **Personal data** dialog, click **Next**
3. On the **Visits** dialog, in the Visitor cards pane, click  next to the card that you want to deassign, and confirm your action in the popup window.  
Repeat this step until you have deassigned all the cards that you want to deassign.
4. Click **Save** to save the current visit with the card assignments.
5. When you deassign the last card assigned to the visitor, the system records this date and time as the check-out time of the visitor.



In the visits table, the status of this visit record becomes 

#### Refer to

- *Using the Settings menu for configuration, page 17*
- *Registering visits, page 26*
- *Approving and declining visitors, page 27*

## 5.3.7

### Checking in and out without card

#### Introduction

If visitors have close escorts, or are restricted to public spaces, then individual cards for visitors may be unnecessary. For such cases there exists the option of checking visitors in and out without cards. For security reasons this option is disabled by default.

**Prerequisite.**

Your system administrator has enabled the special option **Check-in/check-out without card** in the dialog **Settings > Receptionist > Visits**. See the configuration chapter *Using the Settings menu for configuration, page 17* for instructions.

**Process**

When the option is enabled the following occur:

- Any visitor who self-registers at the kiosk computer automatically approves the visit and checks in at the same time.
- The system sets the check-in date and time to the moment of registration.
- The toggle button **Check-in/out without card** appears in the visit editor and the dashboard for the same visit.

**Procedure: Checking a visitor in without card**

If a visitor cannot register himself at the kiosk, but is to check in without a card:

1. register the visit manually, as described in the chapter *Registering visits, page 26*



2. On the dashboard, in the visits table, click the visitor's name in the table or click to edit that visit.
3. On the **Personal data** dialog, click **Next**
4. On the **Visits** dialog, in the **Visitor cards** pane, click **Check-in without card**

**Procedure: Checking a visitor out without card**

If a visitor without card leaves the premises:



1. On the dashboard, in the visits table, click the visitor's name in the table or click to edit that visit.
2. On the **Personal data** dialog, click **Next**
3. On the **Visits** dialog, in the **Visitor cards** pane, click **Check-out without card**

**Refer to**

- *Registering visits, page 26*

**5.3.8****Maintaining visitor profiles**

The system keeps visitor profiles until the visitors themselves, receptionists or administrators delete them.

After a retention period defined in the system settings (default value 12 months) the system deletes records of the visit.

When a visitor or receptionist creates a new visitor profile, the profile receives a unique alphanumeric code. Visitors can log in with this code at the visitor kiosk, and so gain access to maintain their own profiles.

**Notice!**

Protect visitor IDs

Protect visitor IDs carefully from unauthorized access, as they provide access to personal data.

### 5.3.9 Viewing visit records



1. On the dashboard, in the visits table, select a row in the table and click  to edit that visit.
2. On the **Personal Data** dialog, click **Next**
3. On the **Current visit** dialog, click **Show all visits**  
The **Current visit** dialog shows a list of previous visits.

## 5.4 Host

Hosts are employees who receive visits. They can register their own appointments, and browse the system for details of visitors and records of their visits: past, present and future.







### 5.4.1 Logging onto the Host role

1. In your browser, open `https://<My_VisMgmt_server>:5706/main/` for the login screen.
2. Enter the username of an account with the required rights for your role.  
Consult your system administrator if you do not have an account.
3. Enter the password.
4. Click **Login**.

### 5.4.2 Searching and filtering



The toolbar for the Host dashboard contains the following functions:

Label	Function
 N entries	The total number N of visits (each visit is a row in the table).
 Search	Search for arbitrary text among the visits in the table
	Show the visits that were added most recently to the table.
	Open a dialog for selecting filter criteria
	Reset the table to its default view, and revert all filters.
	Open a dialog for creating a new visit entry in the table



### Search

To search names and hosts, enter alphanumeric text in the search box, and press Return.

### Filtering

- To see the visits that are closest to the current time, click **Latest**
- To construct a complex filter from visit status, dates of check-in and check-out, and card numbers, click **Filter**.
  - Enter the desired filter criteria in the popup dialog
  - Click **Apply**  
The system reduces the visits table to only those visit appointments that meet the filter criteria.
- To delete all filter criteria click **Reset**

## 5.4.3

### Registering visits

To register a visit appointment from a first-time visitor:

On the VisMgmt dashboard, in the toolbar above the visits table.



1. Click  to add a row to the visits table
2. On the **Personal Data** dialog, in the **General information** section, enter the personal data that your site requires from visitors.
3. In the **Visit details** section, enter the required details, typically the expected arrival and departure times, plus a reason for the visit.
4. Click **Save** to save the visit appointment.  
The visit appears on the dashboard as a line in the visits table.

## 5.4.4

### Copying visit appointments

To schedule a further appointment with the same visitor

1. On the VisMgmt dashboard, find an existing appointment with the same visitor in the visits table.



2. Click the smaller  icon at the end of the row.
3. On the **Personal Data** dialog, in the **Visit details** section, enter the required details, typically the expected arrival and departure times, plus a reason for the visit.
4. Click **Save** to save the visit appointment.  
The visit appears on the dashboard as a line in the visits table.

## 5.5

### Visitor

Visitors can use the system in kiosk mode on the premises to create their own visitor profiles, and sign required documents before proceeding to reception to collect their visitor cards.

## 5.5.1 Introduction to Kiosk mode

Visitors typically register their visits, and create their own profiles, at a computer that is freely accessible in the reception area of the access-controlled site. For security reasons, the computer's web browser runs in kiosk mode, which allows access only to VisMgmt, and not to multiple tabs, browser settings, or the computer's operating system. All the supported browsers offer kiosk mode, but its exact configuration depends on the browser.

The kiosk computer runs the **Bosch Peripheral Devices** add-on, which allows it physical connections to peripheral devices for scanning ID documents and signatures.

- The URL for kiosk mode is `https://<My_VisMgmt_server>:5706`
- By contrast, the URL for logging on as Administrator, Receptionist or Host is `https://<My_VisMgmt_server>:5706/main/`

## 5.5.2 Creating a visitor profile: Self check-in

### First time visitors

Note that the exact procedure depends on what peripheral devices, such as document and signature scanners, and photo cameras, are available to the kiosk computer.

1. At the welcome screen on the kiosk computer, click **Continue without visitor ID**.
2. On the next screen, click **Self check-in**.
3. On the next screen, select **Scan document**.
4. Follow the instructions on screen for site-specific requirements, such as:
  - scanning ID documents,
  - signing any other legal documents required,
  - capturing a photograph.
5. The system displays the collected information for you to correct and complete.
6. The system asks whether you require special access authorizations, and communicates this to the reception desk, if required.
7. At the end of the check-in process, the screen displays a unique visitor ID.  
Take this ID to the reception desk to receive your visitor card.



### Notice!

Your unique visitor ID

Carefully note your visitor ID, and protect it from unauthorized use. It gives access to your visitor profile. You can use it to log on at the kiosk computer and so expedite your next check-in.

### Repeat visitors

1. Log on at the kiosk with your unique visitor ID.
2. The system displays the collected information for you to correct and complete, if required.
3. Proceed to the reception desk to collect your visitor card.



**Bosch Security Systems B.V.**

Torenallee 49

5617 BA Eindhoven

Netherlands

**[www.boschsecurity.com](http://www.boschsecurity.com)**

© Bosch Security Systems B.V., 2022

**Building solutions for a better life.**

202209191653